

Vip4chain

Chain Lubrication & Dispensing

User and Maintenance Manual

CONTENTS

1. INTRODUCTION
2. GENERAL DESCRIPTION
3. MACHINE IDENTIFICATION
4. TECHNICAL CHARACTERISTICS
5. COMPONENTS
6. UNPACKING AND INSTALLING Vip4chain
7. OPERATION
8. TROUBLESHOOTING
9. MAINTENANCE PROCEDURE
10. DISPOSAL
11. ORDERING INFORMATION
12. DIMENSIONS
13. HANDLING AND TRANSPORTATION
14. OPERATING HAZARDS
15. PRECAUTIONS



Manual drawn in accordance with CE
Directive 06/42

C2047IE - WK 50/11

<http://www.dropsa.com>

Via Benedetto Croce, 1
Vimodrone, MILANO (IT)

t. +39 02 250791

Dropsa products can be purchased from Dropsa branches and authorized distributors, visit
www.dropsa.com/contact or contact us sales@dropsa.com

1. INTRODUCTION

This manual refers to the **Vip4chain** Lubrication device. You can find additional copies and newer revisions of this document from our website <http://www.dropsa.com>. Alternatively contact one of our sales offices.

Please read this manual carefully, as it contains important information on health and safety issues. A copy of this manual should remain with the user of the product.

2. GENERAL DESCRIPTION

The **Vip4chain** has been designed to be used for Air/Oil Chain Lubrication, Spray or dispensing applications.

The unit consists of a base module which houses the electronic control and monitoring system. The unit can then be configured to have one or more (max. 6) dispensing modules which consist of an adjustable micropump (0-30 mm.³) fitted onto a modular mixing base element. This element both monitors the correct oil injection and mixing the oil into an air jet that fires it onto the lubrication point.

The system is completely modular and very compact therefore can be quickly and easily installed by following the instructions in this manual.

3. PRODUCT – MACHINE IDENTIFICATION

The product identification label is located on the front side of the reservoir and contains details of the operating parameters of the unit including input voltage and required air supply.

4. TECHNICAL CHARACTERISTICS

Vip4chain	
Operating Voltage	24 Vdc 110 Vac
Power Consumption	10 W
Air Input Pressure	5 ÷ 8 bar
Remote Alarm Signal	RELAY signal: max 250 V 1 A N.O./N.C.
Operating Temperature	-5 ÷ +55 °C
Max. Working Humidity	90% max
IP Protection Grade	IP-44
Compatible Lubricants	Mineral Oils
Oil Viscosity	32 ÷ 220 cSt
Storage Temperature	-20 ÷ +65 °C



WARNING: do not operate the units outside the parameters indicated.

5. COMPONENTS

Main Unit Vip4chain

Vip4chain Electronic Controller : Controls and monitors all the components on the unit, including chain impulses, air pressure, oil flow, pump activations and oil level.

Pneumatics Circuit: A pressure regulator and filter allows the user to fine tune the air jet to the lubrication point. An integrated air pressure transducer can monitors min/max air pressures. A solenoid valve is used to activate the micropumps at the desired intervals.

Oil Reservoir: A Clear 1 litre reservoir.

Pneumatic micropumps.

The micropumps are installed on the air/oil mixing bases. They are adjustable from 0 to 30 mm³ per cycle. To increase the flow turn the pump adjusting dial clockwise, to decrease counterclockwise.

Modular mixing sub-base with flow sensing.

The modular base has two functions.

Firstly, it monitors that the pumps have correctly injected oil into the unit via a displacement sensor and secondly, it injects the oil into an air stream to be carried to the lubrication point.

No settings are required as the unit automatically configures itself. A green LED will indicate the correct operation of the pump module fitted on top of the base unit.

The signals are then sent back to the Main **Vip4chain** Controller to determine that all the units are functioning correctly.

When a lubrication cycle is in progress, the LED on the sub base indicates the flow of oil from the micropumps. During the standby interval the LED will remain off

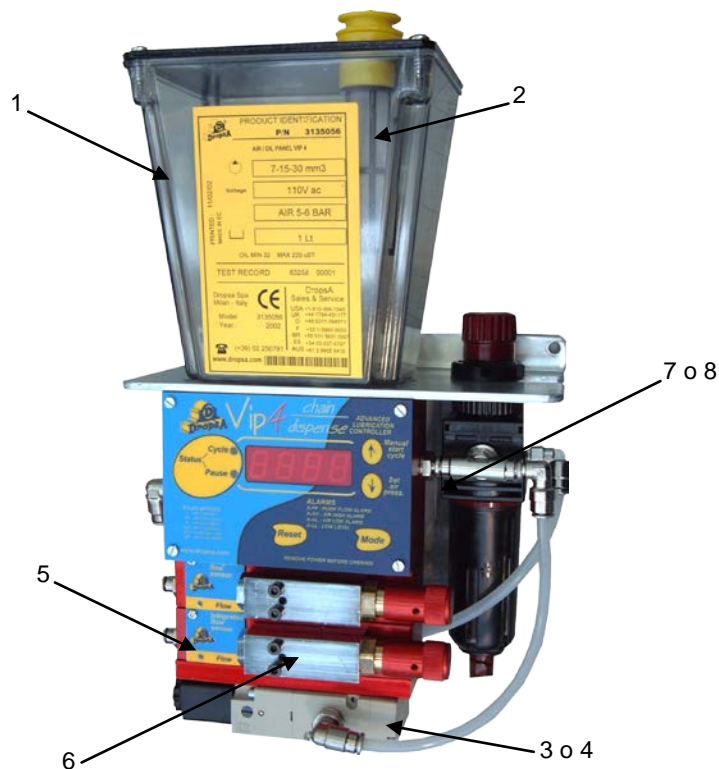

Item	PART NUMBER	DESCRIPTION
1	3044335	Reservoir
2	3130139	Filling Cap & Filter
3	3155148	Solenoid 24V DC
4	3155149	Solenoid 110V AC
5	1524408	Modular Mixing Sub-Base
6	3103116	Adjustable pneumatic Micropump
7	1639118	Wiring Box , 24V Version
8	1639119	Wiring Box, 110V Version

6. UNPACKING AND INSTALLING Vip4chain

6.1 UNPACKING

Once a suitable location has been found to install the unit remove the unit from the packaging. No particular disposal procedures are necessary, however packing should be disposed of in accordance with regulations that may be in force in your area or state.

6.2 INSTALLING THE UNIT

Allow sufficient space around the unit for ease of maintenance. Install at a suitable level for refilling the oil reservoir. Do not install in aggressive environments. Fix the unit using the two fixing holes and 6mm screws.

6.3 ELECTRICAL WIRING

Before carrying out any wiring, ensure that the correct power supply is available. Refer to the identification label on the unit and this instruction manual.

6.4 INSTALLING THE MICROPUMPS ONTO THE BASE MODULE

Normally, you will order a unit already pre-configured with the correct number of micropump and base modules. In the event these need to be altered or changed, the pumps can be removed by taking out the 2 fixing screws as shown on the diagram below. Ensure to place the three O-Rings correctly when installing a new pump module.

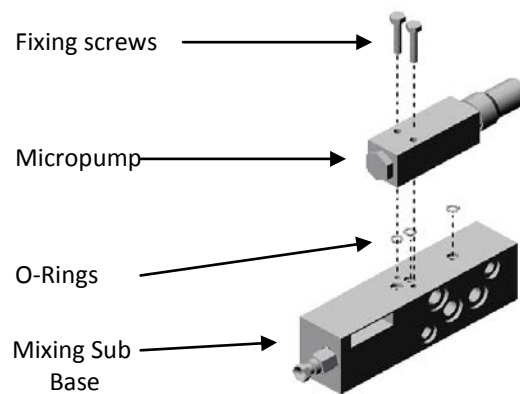

6.5 ADDING OR REMOVING A SUBBASE.

The bases must always be added or removed from the bottom one first. To add or remove a sub-base from the Vip4chain unit

1. Disconnect power and air supply and empty the tank (by removing the unit and pouring out the oil into a container)
2. Disconnect the solenoid valve on the base of the unit using the three fixing screws.
3. Remove the End-plate by undoing the two fixing screws
4. Add a new sub-base (or remove the existing one) as shown in the diagram below. Ensure the Electrical connector and O-rings are all in place before closing the sub base against either another sub-base or the end-plate
5. Add the end-plate and the solenoid valve.

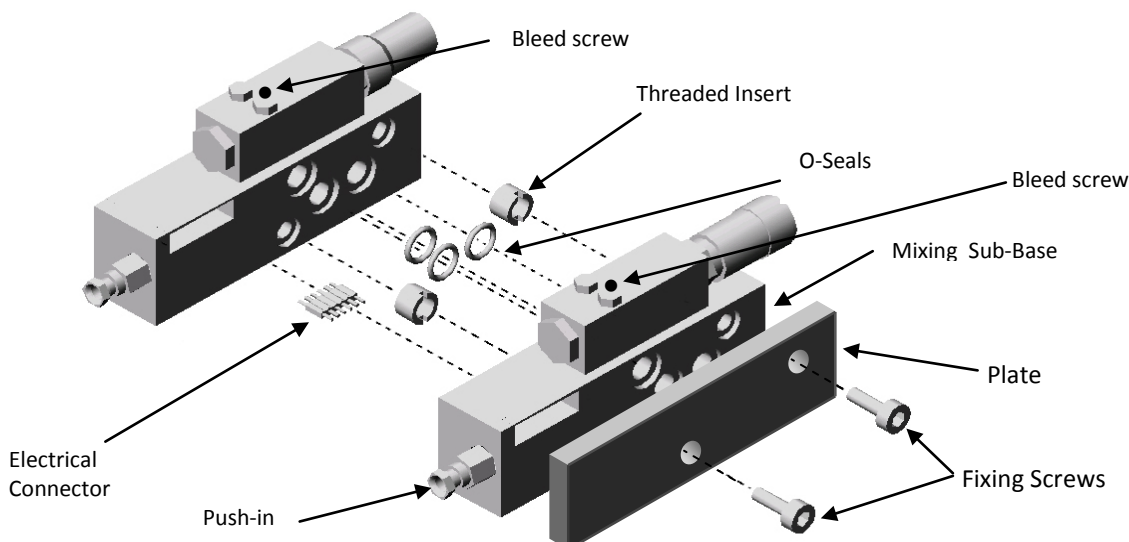

6.5 HYDRAULIC CONENCTIONS

It is suggested to use $\varnothing 4$ mm tube on the air/oil outlets located on the left hand side of the unit.

6.6 PNEUMATIC CONENCTIONS

Connect the Air inlet to the solenoid inlet on the base of the unit using $\varnothing 6$ mm nylon tube.

6.7 ELECTRICAL CONNECTIONS

Before carrying out any type of electrical wiring – ensure that all power is removed from the machine.

Ensure also that the voltage you are using matches that which is indicated on the unit. A label next to the connector also indicates the correct operating voltage of the model you have purchased.

NB: The female connector is purchased separately.

Follow the diagram below to complete the electrical connection.

LEFT HAND SIDE CONNECTOR : Used for input power and remote alarm signal.

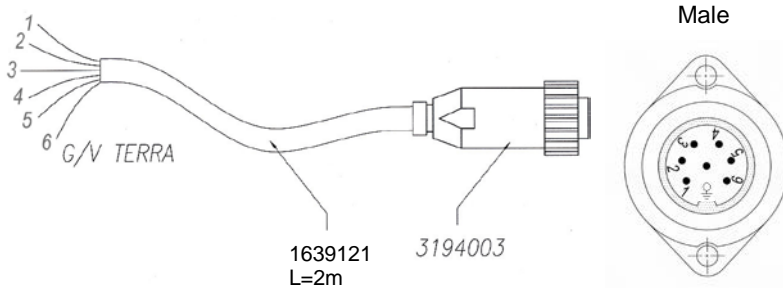

Pin n°	Vers. 24V	Vers. 110V
1	0 V	
2	24 Vdc	/
3	/	110 Vac
4	ALARM NC Contact	
5	ALARM – Common Signal	
6	ALARM – NO Contact	
⊕	Earth	

1639115 – Optional connector and 2m cable assembly

BOTTOM CONNECTOR – Located on the rear power box, located on the bottom face . This is used to connect a remote switch or proximity switch to count impulses from the Chain and time the lubrication cycle.

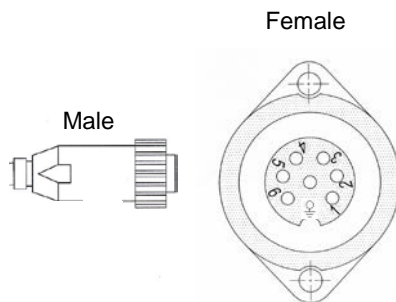

Pin n°	Signal
1	0 V
2	+ 12 V dc
3	SIGNAL IN.o
4	Not used
5	Not used
6	Not used
⊕	Earth

3194002 – Connector for signal

NB: After all connections have been completed ensure the tubing and cables are protected from impacts and are suitably secured.

7 OPERATION

7.1 COMMISSIONING THE Vip4chain

Before using the Vip4chain, the following check list must be observed:

- The Unit has not sustained any damage
- Electrical and Pneumatic connections are correct
- Purge Air from the micropumps by loosening the bleed screw on the micropumps using a 2mm allen key. Once oil is present, tighten the screw
- Power on the unit
- Set the operating parameters as described in this manual.
- To help purge the air from the unit, set the pumps to maximum output by screwing the regulating dial clockwise.

7.2 ZERO-OUTPUT:

If you want to temporarily set zero output on a pump module, you can turn the regulating dial anti clockwise until it stops. Note that if you have sensing enable on the mixing base, you will obtain a pump fault alarm

7.3 SETTING THE OIL OUTPUT ON THE MICROPUMPS

Pump output is set using the red regulating dial.

Turn the dial anti clockwise until it stops. This equals 0 mm³ (pump on zero-output as above). Turn the regulating dial 2.5 turns to achieve 10mm³ (the output sensor will read this output). Each complete turn will now increase the pump output by 5mm³, to a maximum of 30mm³. (See following table)

OUTPUT (mm ³ / colpo)	TURNS
30	6.5
25	5.5
20	4.5
15	3.5
10	2.5
5	1.5
0= Zero Output	Maximum anti-clockwise

7.4 PROGRAMMING THE CONTROLLER

The controller can operate in two modes :

CHAIN MODE: In this mode, the unit will cycle each time an impulse is received from the remote switch. You can program the number of cycles in order to lubricate a chain, and then the unit will go into standby mode. You can set how many impulses from the remote switch have to be detected before returning to cycle mode.

DISPENSE MODE: In this mode, when the unit cycles, it will activate the pumps for a set number of times with an interval between each activation. Following the dispensing cycle the unit goes into standby mode. As with Chain mode, it will count a number of impulses from a remote switch (which can even be a single impulse) before it activates the dispensing cycle again. The user can set the on time and off time of the pump activation.

Air Pressure regulation.

To set the air mixing pressure hold the down key . The air solenoid will open and the air pressure will be displayed on the front panel display. Use the regulator to set the desired air pressure.

Normal Operation

When the unit is powered on, it will automatically start in a standby cycle. During the standby cycle the front panel display will indicate how many more impulses the unit is expecting before commencing a lubrication or dispensing cycle.

By Pressing the UP Key , you can skip the standby cycle and activate the lubrication cycle immediately.

Alarm

In the event of a failure or alarm, the unit will display an alarm code. This can be cleared by pressing the  button. See the Troubleshooting section of this manual.

7.5 SET-UP AND CONFIGURATION OF THE ELECTRONIC CONTROL

SELECT THE OPERATING MODE :

Press and hold the **MODE** key for at least 2 seconds. The unit will go into its set-up mode.















Select the Operation mode DISEPNSE ('dISP') or CHAIN ('ChA') by using the UP/DOWN keys and then press **MODE** to continue.

According to which **MODE** is selected the menu will vary. Follow the step-by-step parameter guide below to setup the unit accordingly. Use **MODE** step to the next parameter and UP/DOWN keys to vary the setting on the current parameter:

CHAIN MODE PARAMETERS

Parameter	Display	Description	Operation	Default
Number of Lubrication Cycles	•	Number of times the pumps are activated during the lubrication cycle. From 0001 a 9999.	Set the value using the and keys	10
Standby Interval	•	Determines the length of the Standby intervals by counting impulses from remote switch.	Set the value using the and keys	100
Standby Multiplication Factor	•	Multiplies the previous value by 1, 10, 100 or 1000 to obtain upto 9,999,000 standby impulses	Set the value using the and keys	1
Number of Micro-Pumps		Number of Micropumps installed on the system with Flow Sensing. Setting this to 0 will disable flow sensing on all micropumps. If you set less than the number of micropumps installed than the nearest ones will be monitored, while the furthest will remain unmonitored. EG. Setting 5 of a 6 pump system will result in the last pump not being monitored..	Set the value using the and keys	Min. 0 Max. 6
Micropump Activen and Air On-Time		During the lubrication cycle, the system will trigger a lubrication shot with each impulse. This setting determines the length of the lubrication Shot and how long the air will remain on for. Ensure that the duration does not exceed the time between impulses from the remote switch for proper operation. 0 a 9,9 sec. Setting this parameter to 0 will cause the Air Shot to remain active for the duration of the impulse from the remote switch	Set the value using the and keys	1
Min air pressure		Minimum Air Pressure monitoring during cycle. Setting 0.0 disables minimum air pressure monitoring. Range 0.0-7.0 bar.	Set the value using the and keys	0,0
Max air pressure		Maximum Air Pressure parameter during cycle. Setting 0.0 disables monitoring. Range 0.0-7.0 bar	Set the value using the and keys	2,5





DISPENSE MODE PARAMETERS

Parameter	Display	Description	Operation	Default
Number of Pump Cycles	• 8888	Number of pump cycles performed when lubricating/dispensing. From 1 to 9999	Set the value using the and  keys 	1
Pump On	P-88	The amount of time the pump remains ON when dispensing. Range: 0.1s to 9.9s	Set the value using the and  keys 	1
Pump Off	P-88	The amount of time the pump remains OFF when dispensing Range : 0.3 to 9.9 s.	Set the value using the and  keys 	1
Number of Micro-Pumps	Pn88	Number of Micropumps installed on the system with Flow Sensing. Setting this to 0 will disable flow sensing on all micropumps. If you set less than the number of micropumps installed than the nearest ones will be monitored, while the furthest will remain unmonitored. EG. Setting 5 of a 6 pump system will result in the last pump not being monitored..	Set the value using the and  keys 	Min. 0 Max. 6
Min air pressure	AL88	Minimum Air Pressure monitoring during cycle. Setting 0.0 disables minimum air pressure monitoring. Range 0.0-7.0 bar.	Set the value using the and  keys 	0.0
Max Air Pressure	AL88	Maximum Air Pressure parameter during cycle. Setting 0.0 disables monitoring. Range 0.0-7.0 bar	Set the value using the and  keys 	2.5
Standby Impulses	• 8888	Number of impulses required to initiate the Lubrication/Dispensing Cycle. Settable from 0001 to 9999.	Set the value using the and  keys 	3

8. TROUBLESHOOTING

The following table highlights some of the most common problems encountered when using the Vip4chain and how to resolve them.

In the event of doubts or the problem is not listed, do not dismantle the unit but contact a DropsA technical centre for assistance.

TROUBLESHOOTING TABLE - Vip4chain		
FAULT/ALARM	PROBABLE CAUSE	SOLUTION
A-PF Pump Fault 	<p>The Flow sensor has not detected flow to the mixing sub-base. Air could be trapped in the system.</p> <p>OR No Oil in system</p>	<p>Purge Air from the system as described in the commissioning part of this manual. After cycling the unit, check to see oil is being dispensed visually.</p> <p>Check the Oil Level</p>
A-AH Air High 	<p>Air Setting is incorrect or the delivery tube has become clogged.</p>	<p>Hold the DOWN key to see the current air pressure and ensure that it is lower than the Air High setting in the set up menu.</p> <p>Check that the tubes have not become clogged resulting in an Air High Alarm.</p>
A-AL Air Low 	<p>Air Setting is incorrect or the delivery tube has become detached causing a fall in air pressure</p>	<p>Hold the DOWN key to see the current air pressure and ensure that it is higher than the Air Low setting in the set up menu.</p> <p>Check that the tubes have not become detached resulting in a pressure loss.</p>
A-LL Oil Low 	<p>Low oil level in tank or Air Lock.</p>	<p>Add Oil to tank. If the alarm does not clear, try purging air from the hydraulic circuit as described in the commissioning portion of this manual.</p>

9. MAINTENANCE PROCEDURE

The Vip4chain requires only minimal maintenance. Periodically check that the unit is intact and does not present leaks.

As required, or at least once a year, clean or substitute the refilling filter (3130139)

The unit does not require any special tooling to operate or maintain it. It is recommended that suitable protective clothing (including gloves and safety glasses) are worn when maintaining the unit in order to avoid hazards to equipment or persons.

Be sure that all electrical and pressurized hydraulic components are disconnected prior to any maintenance.

10. DISPOSAL

During maintenance or disposal of the machine care should be taken to properly dispose of environmentally sensitive items such as oils or other lubricants. Refer to local regulations in force in your area.

When disposing of this unit, it is important to ensure that the identification label is also destroyed.

11. ORDERING INFORMATION

VERSIONS

N° Pump units	Vip4chain 24 V DC	Vip4chain 110 V AC
1	3135121	3135131
2	3135122	3135132
3	3135123	3135133
4	3135124	3135134
5	3135125	3135135
6	3135126	3135136

12. DIMENSIONS

Allow 100 mm on each side for easy maintenance.

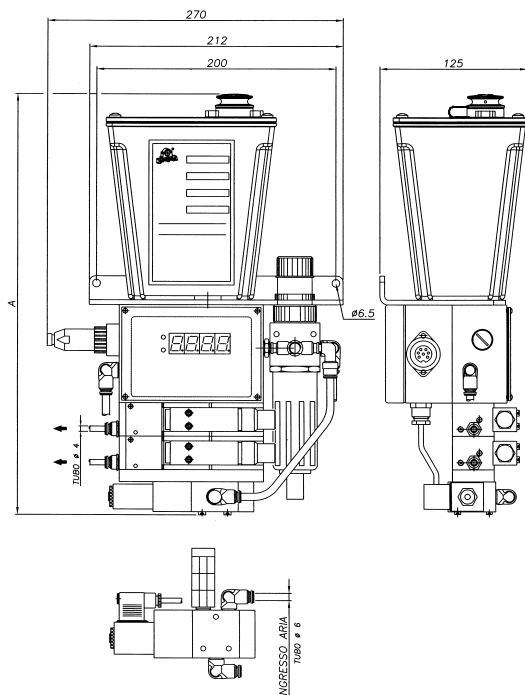

Pump Elements	A (mm)	Weight (Kg.)
1	331	3,8
2	359	4,3
3	387	4,8
4	415	5,3
5	448	5,8
6	471	6,3

13. HANDLING AND TRANSPORTATION

Vip4chain **Units** are packed and dispatched in cardboard containers. During transportation and storage always maintain the unit the right way up as indicated on the box.

On receipt check that the packaging has not been damaged and store the pump in a dry place.

14. OPERATING HAZARDS

It is necessary to read and understand the possible hazards and risks involved when using a lubrication pump. The operator must fully understand the hazards explained in this manual.

Electrical Power

No maintenance must be performed on the unit without having detached and isolated the power supply and ensuring that it cannot be reconnected for the duration of the maintenance task. Always remember to ensure that equipment is properly earthed.

Flammable substances.

Mineral oils generally used in lubrication systems are not normally flammable. However, it is desirable to avoid contact with extremely hot substances or naked flames. Ensure that the machine that the lubrication system is installed onto contains the necessary fire extinguishing devices.

Pneumatic & Hydraulic Pressure

Before any maintenance or connection task, ensure that all pressure has been properly bled from the system. Residual pneumatic or hydraulic pressure can cause the release of undesired spurts of liquid, which may hit the operator. Always wear safety glasses and glove when working with pneumatic and hydraulic systems.

Noise and Vibration

The Pump does not produce excessive vibration or noise (less than 70 dB(Non si deve effettuare alcun intervento sulla macchina prima di aver scollegato la stessa dall'alimentazione elettrica ed accertato che nessuno possa ricollegarla durante l'intervento.

15. PRECAUTIONS

- ❑ Contact with Oil. The operator should wear protective clothing to avoid contact with the lubricant.
- ❑ Personnel must use personal protection equipment, clothing and tools adequate for the location and the use of the panel both during its operation and during maintenance operations.
- ❑ The use of the equipment referred to in this manual must be entrusted to qualified personnel with a basic knowledge of mechanics, hydraulics and electrical systems.
- ❑ It is the responsibility of the installer to use tubing suitable for the system; the use of inadequate tubing can cause problems with the pump, injury to persons and create pollution
- ❑ Loosening of connections can cause serious safety problems; carry out a check before and after installation and, if necessary retighten them.
- ❑ Never exceed the maximum working pressure values permitted for the panel and the components connected to it.
- ❑ Before any maintenance, cleaning or other operation disconnect the power supply, close off the air supply and discharge the pressure from inside the equipment and the tubing connected to it.
- ❑ Do not subject the panel, the connections, the tubing or parts under pressure to violent impacts; damaged tubing or connections are dangerous and should be immediately replaced After long periods of inactivity check air tightness of all parts subjected to pressure
- ❑ Incompatible fluids may cause danger

Examples of incompatible/non-permissible Fluids.

Fluid	Danger
Lubricants containing abrasive components.	Premature wear of pump
Lubricants containing silicon.	Pump failure
Petrol, Solvents, flammable liquids	Fire, explosion, seal damage.
Corrosive products	Pump damage, danger to persons.
Water	Pump oxidization
Food Products	Contamination of product